

CONTROL UNIT

1. INSTALATION

Following rules have to be respected during the RP 5330 Control Unit installation

- Unit can be fixed into wall or steel frame only in horizontal position. It's fastened by 4 screws M16.
- Unit has to be easy accessible for maintenance, adjusting and repair works.
- Maximum permissible ambient temperature is limited to 60°C.
- Distance between control unit and safety valve, measured along the Lifting/Loading air pipeline is limited to 15 meters. The pipeline has to be carefully cleaned. It's necessary to check, if all unions are leak-tight.
- **Pressure air supply pipeline has to be equipped by shut-off valve and air filter.**
- Pressure tapping line has to create minimum 1 meter loop under the control unit. It's necessary to fill the loop by condensate, before the unit connection. Pipeline has to be fixed to prevent vibration.
- In areas, where a freeze can be expected, the control unit must be equipped by internal heating (optional -see article "Internal heating") or it must be placed into special heated shelter/room. More, the tapping lines and the pressure air supply pipeline have to be insulated/heated.
- **It's prohibited to place any valve (nor shut-off, nor other type), fitting or pressure connection into pressure tapping line.**

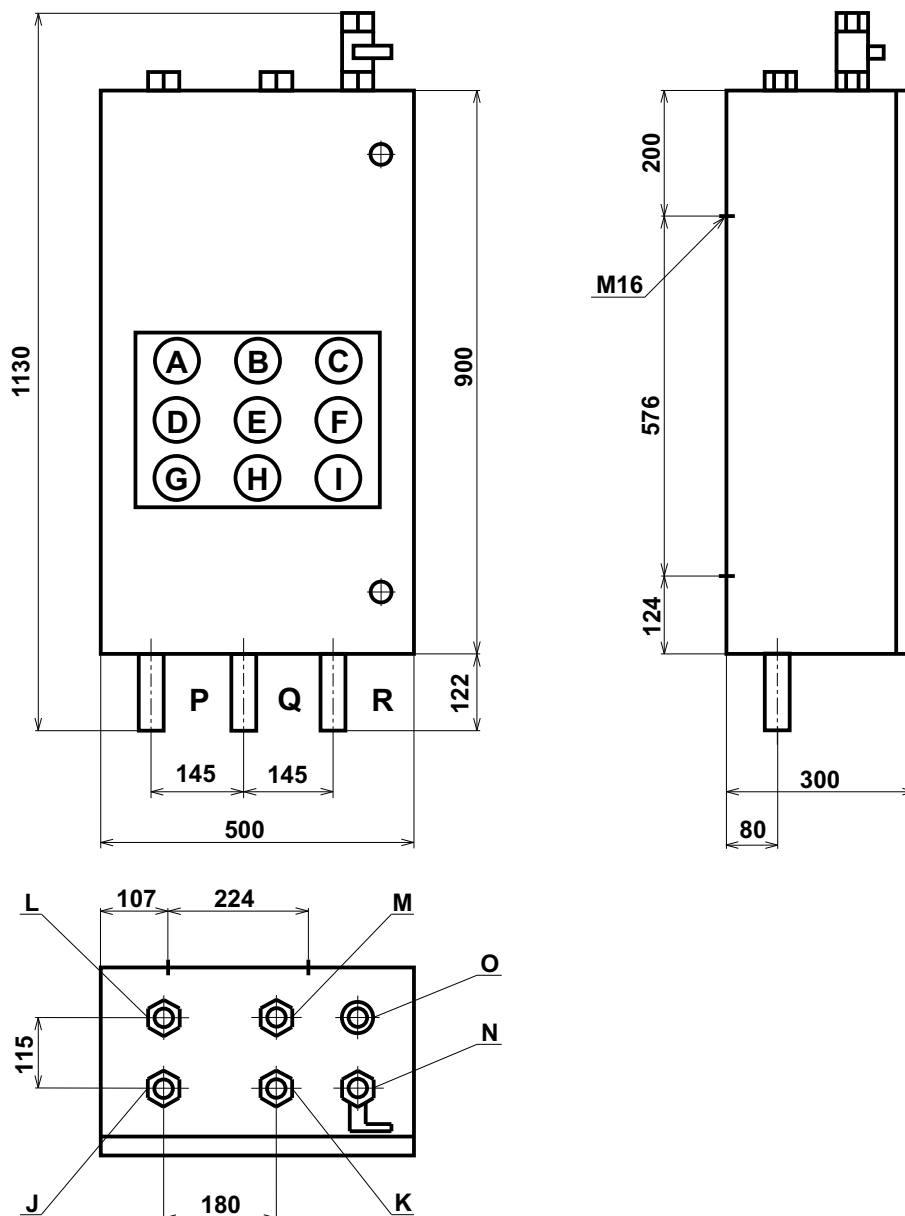

Position	Description	Connection
A	Lifting air pressure gauge - 1 st safety valve	M12 x 1,5
B	Loading air pressure gauge - 1 st safety valve	M12 x 1,5
C	Operating air pressure gauge	M12 x 1,5
D	Lifting air pressure gauge - 2 nd safety valve	M12 x 1,5
E	Loading air pressure gauge - 2 nd safety valve	M12 x 1,5
F	Control air pressure gauge	M12 x 1,5
G	Tapping line pressure gauge I	G ¹ / ₄ "
H	Tapping line pressure gauge II	G ¹ / ₄ "
I	Tapping line pressure gauge III	G ¹ / ₄ "
J	Lifting air connection - 1 st safety valve	Tube Ø 18x2 or Ø 18x1,5
K	Loading air connection - 1 st safety valve	Tube Ø 18x2 or Ø 18x1,5
L	Lifting air connection - 2 nd safety valve	Tube Ø 18x2 or Ø 18x1,5
M	Loading air connection - 2 nd safety valve	Tube Ø 18x2 or Ø 18x1,5
N	Control air On-Off valve	Tube Ø 16x2 or Ø 16x1,5
O	Remote control connection	Cable LYS 3x0,75
P,Q,R*)	Tapping line connection	Tube Ø 32x6 or Ø 33,7x5

- *) P = impulse I1
Q = impulse I2
R = impulse I3

Pressure air quality according ISO 8573-1 standard

- Class of dust particles 4 or better (i.e. particle max. size 15 µm, concentration max. 8 mg/m3)
- Class of water 4 or better (i.e. condensation point max. +3°C), for the ambient temperature below freezing point, the control unit heating is recommended
- Class of oil 3 or better (i.e. concentration max 1mg/m3)

Pressure air consumption

- sleep mode consumption (safety valve closed, air leak trough air nozzles) 1,5 Nm3/h
- consumption when the safety valve starts to open (short time, peak) 8,5 Nm3/h
- consumption when the safety valves are open (air leak trough diaphragm valve) 5,0 Nm3/h

Tapping line connection

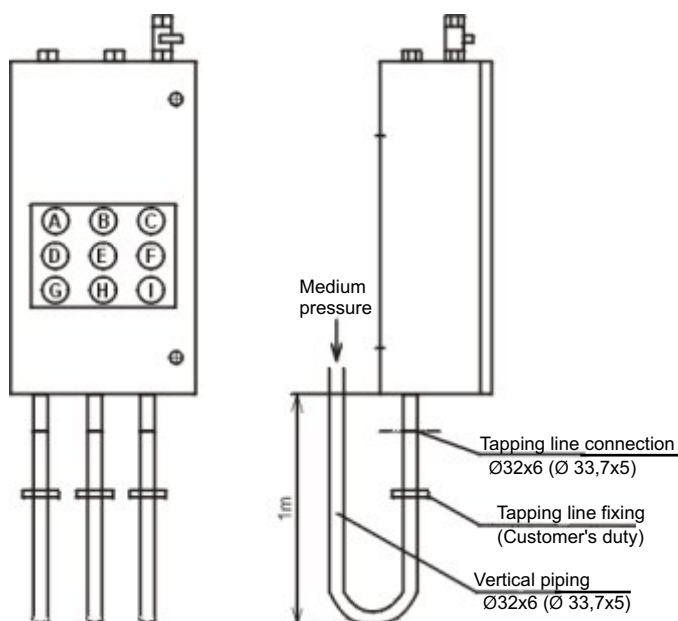

- tapping line isn't part of delivery

Safety valve connection to Control Unit

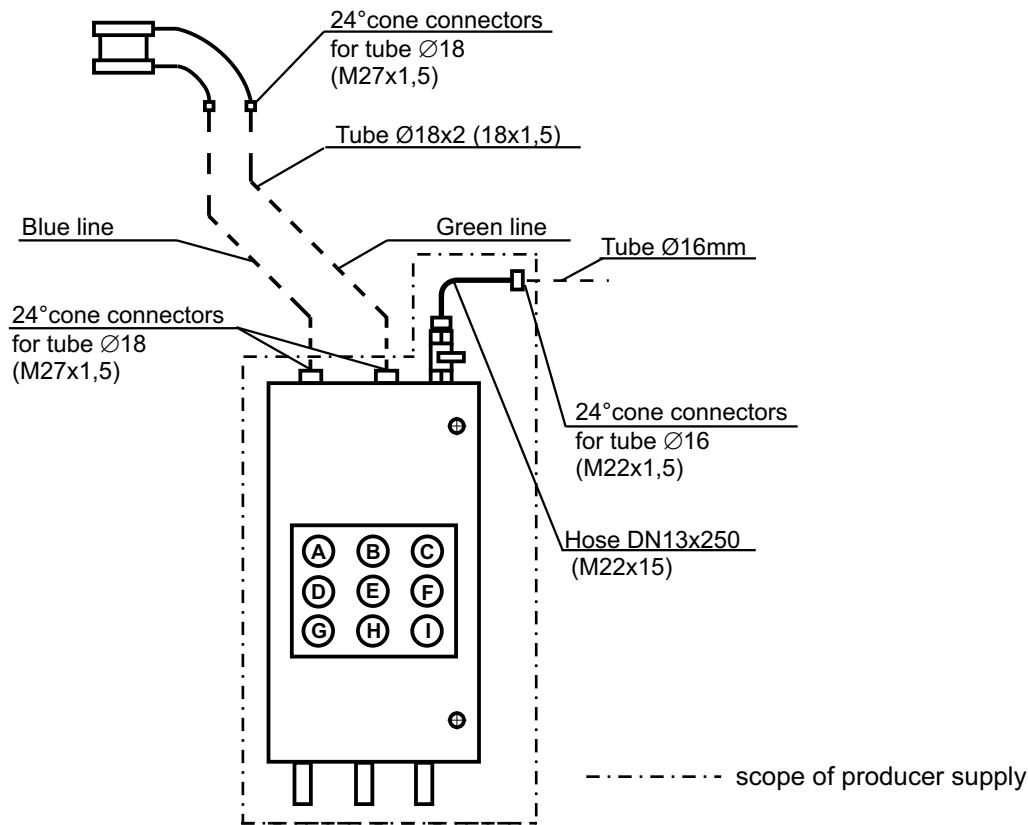

- connection line isn't part of delivery
- **tubes must be carefully cleaned before assembly**
- it's recommended to paint the tubes to blue and green (same as control unit connection)

Safety valve connection to Control Unit

Only tubes with right dimension can be used (Ø18x2 or Ø18x1,5). Ends must be cut perpendicularly and deburred! Special attention must be given to sealing rings. Generally, stainless steel tubes are recommended, in case of vet air it's necessity. Tubes, or their ends at least, should be painted to:

green - loading air
blue- lifting air

Connecting points control unit and safety valve are marked by the same color. It will prevent wrong air piping connection.

Aerating system

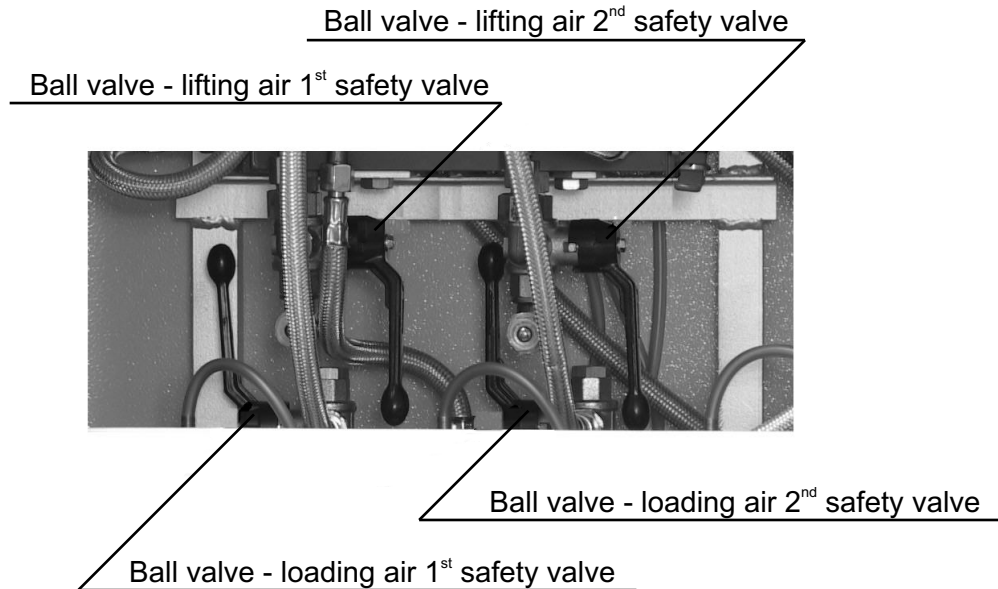

Ball valve

- **open:** lever forward, the pressure air (lifting respective loading) is brought into safety valve air cylinder
- **close:**
 - lever downward (lifting air) } pressure air supply into safety valve air cylinder is broken, the respective
 - lever upward (loading air) } cylinder space is connected to atmosphere

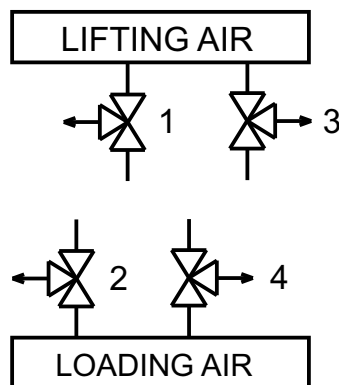

Mode of connection	Ball valve - position			
	Lifting 1	Loading 1	Lifting 2	Loading 2
N1	1 - Open	2 - Open	3 - Close	4 - Close
T1	1 - Close	2 - Open	3 - Close	4 - Close
N2	1 - Open	2 - Open	3 - Open	4 - Open
T2	1 - Close	2 - Open	3 - Close	4 - Open
TN	1 - Close	2 - Open	3 - Open	4 - Open
NT	1 - Open	2 - Open	3 - Close	4 - Open

Diagram with modes of connection is placed on internal side of control unit door.

N1, T1 - mode of connection for one safety valve
N2, T2, TN, NT - mode of connection for two safety valve

Remote control

- Each control unit is equipped by solenoid valve. It's highly recommended to connect the control unit with boiler control system/room and to utilize the possibility of safety valve remote control (regular testing of valves, manual or valves, manual or automatic opening in emergency situation).

- 2W solenoid valve, type 2 VE 6I, DN6, PN1, 220V/8W/50Hz, producer Prešov, Slovakia
Manufacturer reserves the rights to change the solenoid valve.

- Remote control can't be used for safety valve, connected to control unit by T1 or T2 modes (more see paragraph Aerating System)

- **It's prohibited to use switch for remote control circuit. Only the push button can be used.**

- Wiring of remote control should be designed as simple as possible - it's part of emergency system.

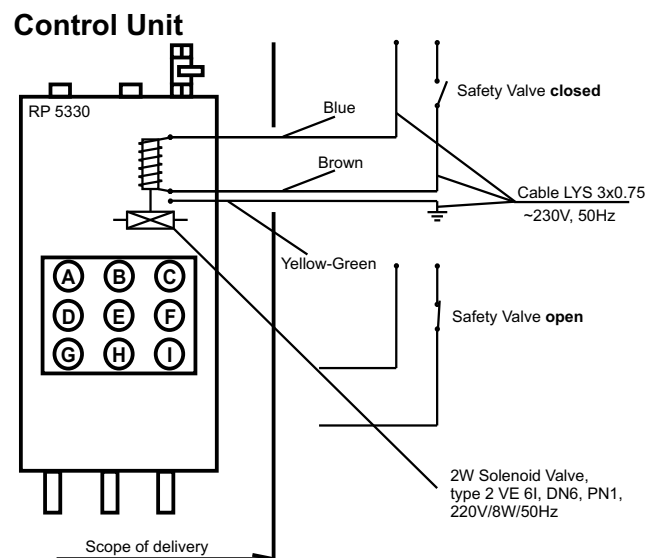

Internal heating

If the control unit is placed in the area, where the ambient temperature can drop below 0°C (shelter on the roof of boiler room etc.), it must be equipped by internal heating. The heating is formed by three electric heating units (power 60W each) and thermoregulator and the insulation is added inside the control unit. Control unit, equipped by these heating can reliable operate in the area with minimum ambient temperature not lower than -10°C. Heating is fed through connector (230V/50Hz), placed in left lower part of control unit. Wiring diagram see single leaflet *071/03/04/A.

Tapping lines and pipeline for pressure air supply have to be insulated, eventually heated too, to prevent condensate freezing.

If such situation occurs, it's necessary immediately defrost the control unit/pipelines and carefully check all pressure parts of system. See also the article "Trouble shooting"

General notes Control Unit installation

- Control unit must be placed in safe distance from safety valve. It's recommended to assure visibility of safety valves from the point of control unit location. Safe escape corridors and enough space for maintenance works should be taken into account too.
- Control unit can be placed outside the boiler/protected device, the distance is limited by maximum length of Lifting/Loading air pipeline (15 meters).
- Prior the installation, the inspection of the control unit and it's documentation must be done (comparison between the project data and values given at control unit nameplate and documentation).

Compulsory activities after Control Unit installation

- Disconnect the hoses and blow through the air piping between the control unit and safety valve.
- Connect the piping back and check, if it's leak free.
- Check the function of control unit.
- Set the position of aerating system ball valves according the diagram placed on unit door.

These activities are done by people/organization approved by control unit manufacturer.

Example of Safety Valve and Control Unit installation

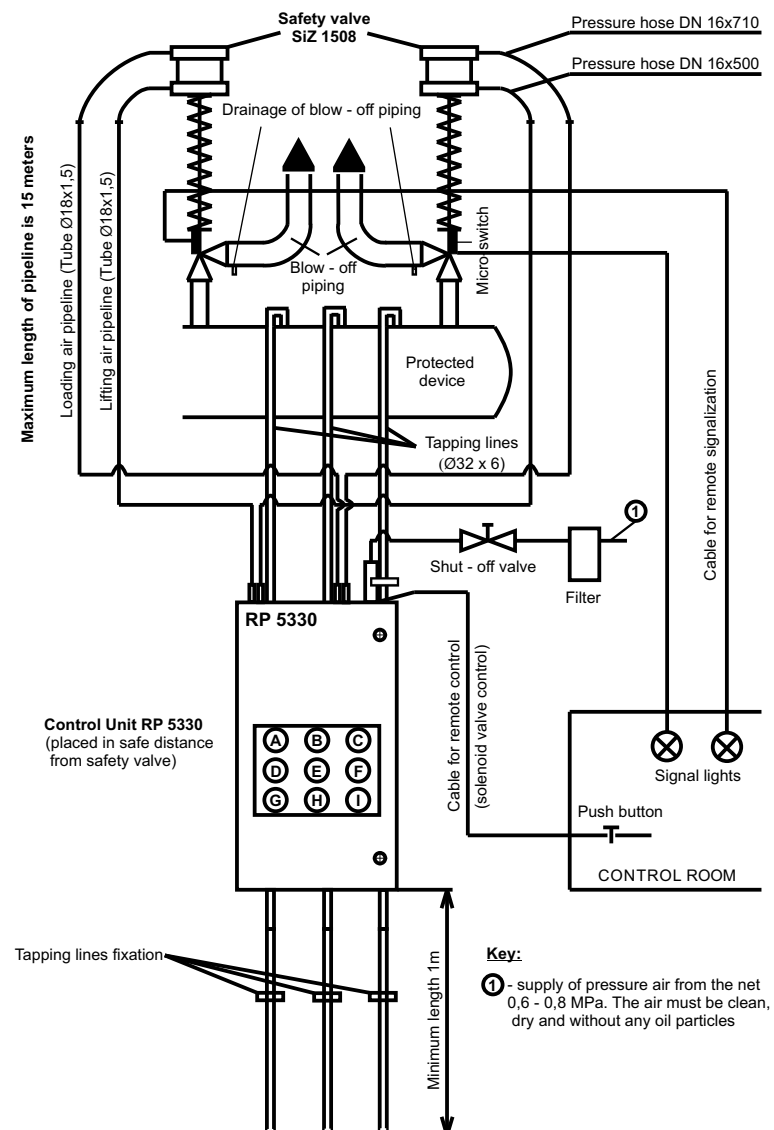

2. CONTROL UNIT OPERATION

All activities connected with control unit operation launch are done by people/organization approved by control unit manufacturer.

Control unit can be operated only with suitable safety vale. In the case, you mention to use it with other tan LDM safety valve production, please consult it with control unit manufacturer.

Operation launch must be done very carefully, it prevents possible problems during control unit operation. Launch is divided into two stages.

Stage 1 - all activities done when the boiler is cold (out of operation)

Stage 2 - activities done after boiler start (boiler in operation)

Regarding the fact, that all devices (control unit, safety valve) are during Stage 2 under operation pressure, it's necessary to strictly keep all rules for safe work. Only skilled and trained people with certification can do these works.

Stage 1:

- Check, if compulsory activities after control unit installation were done
- Check, if the control unit and the safety valves are placed on right position (coupled in right order)
- Check, if the Loading/Lifting air piping between control unit and safety valve is connccted properly to the safety valve air cylinder. Loading air piping (green line) must be connected to upper part of air cylinder, Lifting air piping (blue line) must be connected to lower part of air cylinder. **Be careful not to reverse the hoses.**
- Check, if the position of aerating system ball valves lever agree with mode of connection
- Make the functional test of control unit

Stage 2:

- Check the control unit opening overpressure setting
- Test remote control

Regular operation

It's necessary to provide continual supply of pressure air (0.4 - 0.8 MPa) into control unit, to guarantee trouble free function of safety valves (and control unit too, of course). The control unit must be protected again damage and misuse, and once per week check the pressure gauges, viewed in doo'rs window. Right pressure values are:

A	0.4 ± 0.05 MPa (4 ± 0.5 barg)	Lifting air, 1 st safety valve
B	0.4 ± 0.05 MPa (4 ± 0.5 barg)	Loading air, 1 st safety valve
C	0.4 ± 0.05 MPa (4 ± 0.5 barg)	Operating air pressure
D	0.4 ± 0.05 MPa (4 ± 0.5 barg)	Lifting air, 2 nd safety valve
E	0.4 ± 0.05 MPa (4 ± 0.5 barg)	Loading air, 2 nd safety valve
F	60.0 ± 10.0 kPa (0.6 ± 0.1 barg)	Control air pressure

It's necessary to reset right value by using reducing valves, placed inside control unit, if the gauge shows other then right value.

Shut-off ball valve (position S) is placed inside the control unit. It has the same function as solenoid valve, to close supply of air to nozzles (position V). It's lever must be set forward during the control unit operation, closing position is upward.



3. MAINTENANCE

a) pressure air resetting - value 0,4 MPa (pressure gauges A, B, C, D, E) is set by reduction valve T, value 60,0 kPa (pressure gauge F) is set by reduction valve U. Be carefull, if the value of air pressure on gauge F drop under 40.0 kPa, the safety valves can spontaneously open.

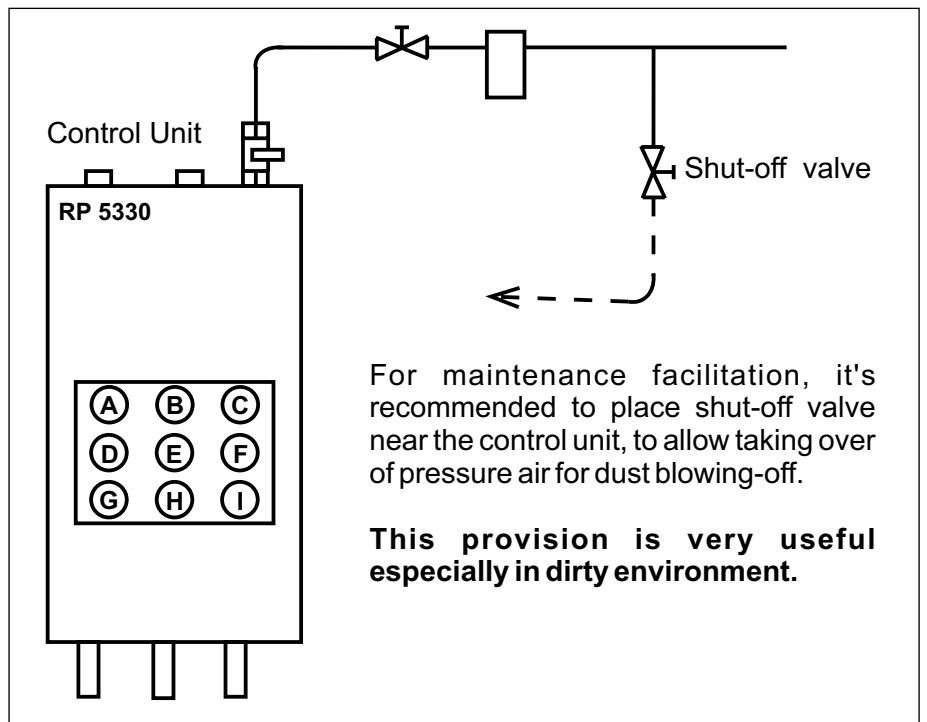
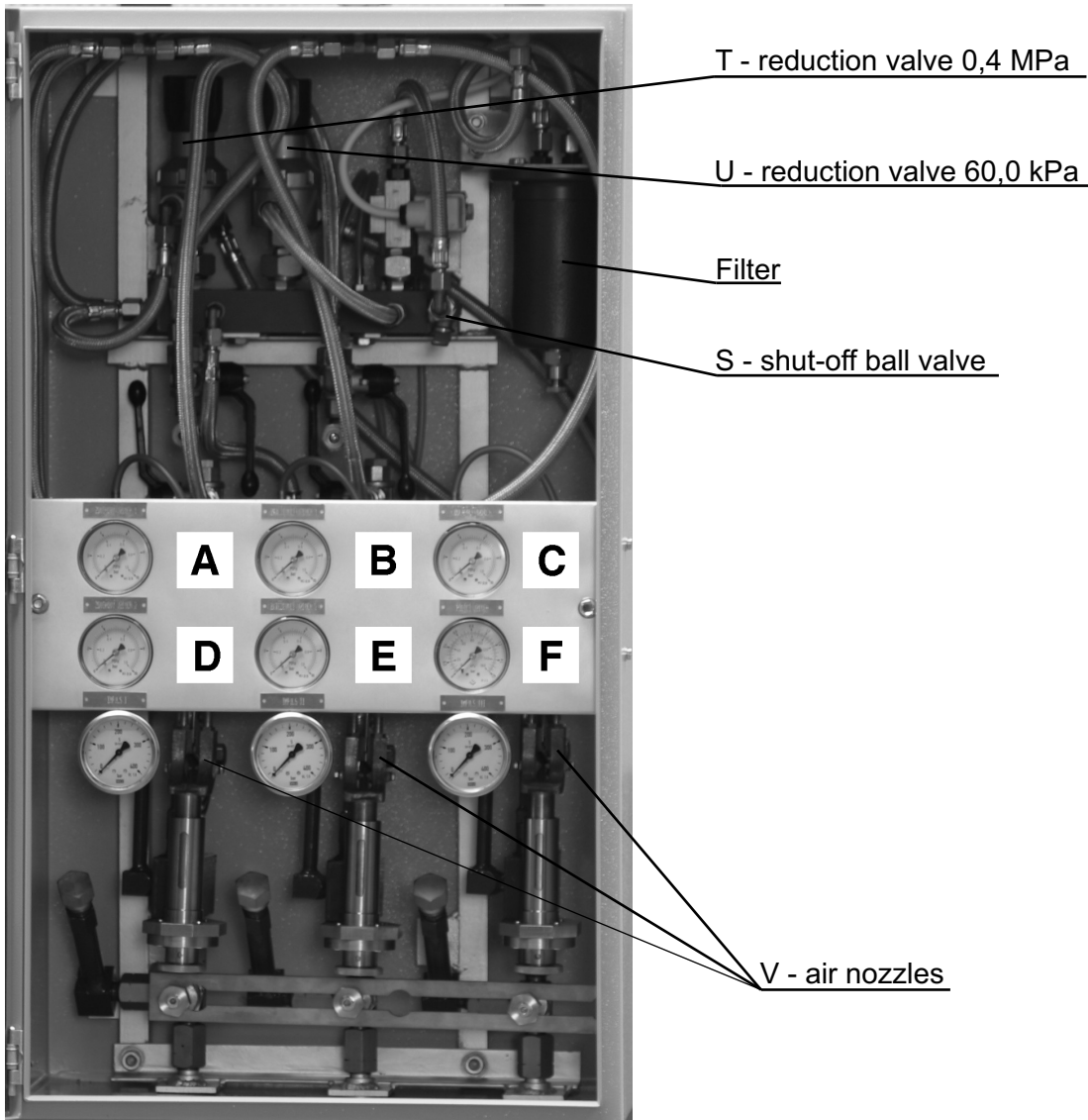

b) checking/cleaning of air nozzles V. For the cleaning, usage of the wire W according following drawing is recommended. If this activity is done during the operation of boiler (or other protected device), it's necessary to lock respective diaphragm valve. Other possibility is to do it with closed pressure air delivery into control unit (Operating air On-Off valve N is closed). Back opening of the N On-Off valve have to be done very carefully and slowly. Air pressure on gauges A, B, C, D and E should rise almost simultaneously. Quick opening of N valve can cause undesirable opening of safety valves.

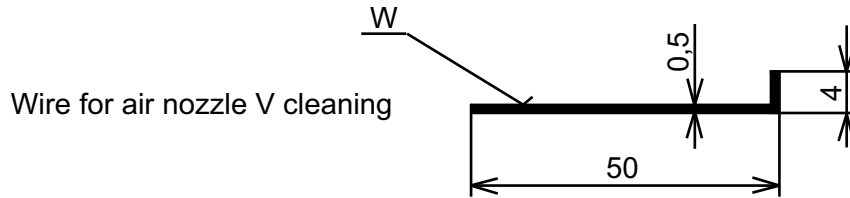

c) water and sludge removing from the filter. Cleaning is carried out with drainage bolt, placed on lower side of the control unit. If some water or oil is find out, the filter insert have to be cleaned. It's carried out, when the pressure air delivery into control unit is closed. First, the filter cover must be removed after unscrewing the bottom nut. It's recommended to slightly turn by the cover, not to tear off the rubber sealing (is hard work to put it back) and then to remove the cover and bronze filter insert. Then, the filter insert has to be washed in gasoline and blow through by pressure air. Finally, the filter is assembled back into opposite order and the On-Off valve N is open again - procedure is explained in previous paragraph B).

Note: The above mentioned cleaning of air nozzles and filter is necessary especially in dusty environment and/or if the air contains oil or water and air pipeline is corroded.

Trouble shooting

Trouble:

Gauge B or E doesn't read 0,4 MPa - safety valves can open.

Solution/elimination:

Check, if the loading air ball valves are open and tight. Check the loading air piping tightness (connection between control unit and safety valve).

Trouble:

Control unit is freezed (freezed condensate in tapping line and coil springs/Bourdon spirals) - in this case, the safety valves open prematurely.

Solution/elimination:

- 1 - immediately defrost the control unit by hot air (it's recommended to loose tapping line pressure gauges)
- 2 - check, if the coil springs (Bourdon spirals are not damaged. If not, check) reset opening pressure. If yes, change the coil springs and reset the opening pressure too.

Trouble:

Broken control air tube (plastic tube to or from air nozzles). Safety valves open before the set pressure is reached.

Solution/elimination:

Check the plastic tube, change the damaged.

Trouble:

Damaged/broken diaphragm in diaphragm valve. Safety valves open before the set pressure is reached.

Solution/elimination:

Check the diaphragm, change the damaged.

Trouble:

Broken loading air pressure hose. Safety valves open before the set pressure is reached.

Solution/elimination:

Check the hose, change the damaged.

NOTE:

Above mentioned troubles in any case don't influence safety of protected device.

Yearly revision

- air nozzle checking/cleaning
- pressure gauges checking/adjusting
- air filter cleaning

3 - years revision

Carry out general cleaning and testing of all parts of the control unit. If necessary, the diaphragms of diaphragm valves should be changed together with all damaged parts (air hoses, plastic tubes, pressure gauges, pressure reducing valves etc.). The air piping between the control unit and safety valves should be checked too.

Spare parts for 3 - years operation

air filter insert - 1 pc.
diaphragm - 3 pcs.
O-ring 9x5 - 6 pcs.

4. TRANSPORT AND STORAGE

The Control Unit must be transported in protected transport devices, properly fixed to prevent it's damage by other transported goods.

In the time of dispatch, the Unit is placed in the box. Pressure hose (pressure air inlet) is connected to Control Unit.

The control Unit must be stored inside the dry (maximum relative humidity 75%), sheltered places with nonaggressive atmosphere. The storage temperature must be in range from 0°C to +60°C. It's recommended to keep the Control Unit in the original packaging. The Unit must be protected from shocks and impacts. It's not allowed to remove the tube/hose end covers prior the Unit installation.

5. CONCLUSION

For reliable and trouble free operation of control unit, it's necessary to keep the rules and instructions given in this leaflet. It's highly recommended to order authorized service for control unit operation launch, for setting of opening pressure and for regular maintenance/revision.

Generally, the right opening pressure is set by manufacturer. In place resetting, provided by authorized service organization with the aid of special tools, can be done even when the protected device is without pressure.

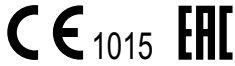

ADDRESS OF FACTORY

LDM, spol. s r.o.
Litomyšlská 1378
560 02 Česká Třebová
Czech Republic

tel.: +420 465 502 511
fax: +420 465 533 101
E-mail: sale@ldm.cz
<http://www.ldmvalves.com>

REGIONAL OFFICES

LDM, spol. s r.o.
Office in Prague
Podolská 50
147 01 Praha 4
Czech Republic

tel.: +420 241087360
fax: +420 241087192
E-mail: tomas.suchanek@ldm.cz

LDM, spol. s r.o.
Office in Ústí nad Labem
Ladova 2548/38
400 11 Ústí nad Labem - Severní Terasa
Czech Republic

tel.: +420 602708257
E-mail: tomas.kriz@ldm.cz

SERVICE ORGANIZATION

LDM servis, spol. s r.o.
Litomyšlská 1378
560 02 Česká Třebová
Czech Republic

tel: +420 465502411-13
fax: +420 465531010
E-mail: servis@ldm.cz

LDM SUBSIDIARIES ABROAD

OOO "LDM Promarmatura"
Jubilejnyi prospekt, dom.6a, of. 601
141407 Khimki
Moscow Region
Russia

tel.: +7 495 7772238
fax: +7 495 7772238
mobile: +7 9032254333
e-mail: inforus@ldmvalves.com

TOO "LDM"
Shakirova 33/1, kab. 103
100012 Karaganda
Kazachstan

tel.: +7 7212566936
fax: +7 7212566936
mobile: +7 7017383679
e-mail: sale@ldm.kz

LDM, Bratislava s.r.o.
Mierová 151
821 05 Bratislava
Slovakia

tel: +421 243415027-8
fax: +421 243415029
E-mail: ldm@ldm.sk
<http://www.ldm.sk>

LDM Armaturen GmbH
Wupperweg 21
D-51789 Lindlar
Deutschland

tel: +49 2266 440333
fax: +49 2266 440372
mobile: +49 1772960469
E-mail: ldmarmaturen@ldmvalves.com

LDM, Polska Sp. z o.o.
ul. Bednorza 1
40-384 Katowice
Polska

tel: +48 327305633
fax: +48 327305233
mobile: +48 601354999
E-mail: ldmpolska@ldm.cz

LDM Bulgaria Ltd.
z.k.Mladost 1
bl.42, floor 12, app.57
1784 Sofia
Bulgaria

tel: +359 2 9746311
fax: +359 2 8771344
mobile: +359 888925766
E-mail: ldm.bg@ldmvalves.com

www.ldmvalves.com

LDM, spol. s r.o. reserves the right to modify or improve the designs or specifications of such products at any time without notice
Guarantee and after guarantee service provided.